

GRADO

2023

Wohn- und Esszimmersystem

Living and dining room system





Planungsbeispiele *Planning examples*



4–29

4–9

10–15

16–23

24–29

Exterior – stilgebende Elemente *Exterior – style elements*

Material, Oberfläche & Farbe *Materials, finish & colour*

Griffe *Handles*

Stoff- und Lederkollektionen *Upholstery collections*

Beispielartikel *Sample articles*

30–31

31

32

33

Interior – Komfort und Ausstattung *Interior – Comfort and features*

34–35

Legende *Legend*

Breite *Width*



Höhe *Height*



Tiefe *Depth*



Lack matt *Lacquer matt*



Lack hochglänzend *High-gloss lacquer*



Holz *Wood*



Stoff *Fabric*



Leder *Leather*



Kunstleder *Artificial leather*



Klarglas *Clear glass*



Satiniertes Glas *Frosted glass*









4-5

- 47001 Sideboard mit Kufen *Sideboard with runners*
 ↕ 228,2 cm ↕ 85,3 cm ↕ 40,0 cm
 BC – Kristallbuche *Beech crystal*
 LW – Lack Weiß *White lacquer*
 Kufen Weiß *Runners white*
- 93806 Stuhl R5 mit Kreuzgestell und Armlehne
Chair R5 with criss-cross base with arm rest
 ↕ 56,0 cm ↕ 85,0 cm ↕ 56,5 cm
 7F – Vegane Lederalternative *Vegan leather alternative*
 Pure Eucalyptus
 Kreuzgestell Weiß *Criss-cross base white*
- 93803 Stuhl R5 mit Kreuzgestell *Chair R5 with criss-cross base*
 ↕ 50,0 cm ↕ 85,0 cm ↕ 56,5 cm
 7F – Vegane Lederalternative *Vegan leather alternative*
 Pure Eucalyptus
 Kreuzgestell Weiß *Criss-cross base white*
- 93827 Esstisch CUBE *Dinner table CUBE*
 ↕ 200,0 cm ↕ 75,0 cm ↕ 95,0 cm
 LW – Lack Weiß *White lacquer*
- 87858 Korpuselement mit Rahmengestell
Carcass element with frame rack
 ↕ 93,2 cm ↕ 139,7 ↕ 40,0 cm
 S5 – Lack Piniengrün *Pine green*
 Rahmengestell Weiß *Frame rack white*
- 47002 Vorschlag mit Sockelgleitern *Suggestion with plinth gliders*
 ↕ 213,2 cm ↕ 216,9 ↕ 41,7 cm
 BC – Kristallbuche *Beech crystal*
 LW – Lack Weiß *White lacquer*

6-7

- 47005 Sideboard mit Sockelgleitern *Sideboard with plinth gliders*
 ↕ 168,2 cm ↕ 76,1 cm ↕ 40,0 cm
 BC – Kristallbuche *Beech crystal*
 LW – Lack Weiß *White lacquer*
- 83745 Couchtisch mit Rahmengestell *Coffee table with frame rack*
 ↕ 95,0 cm ↕ 39,6 cm ↕ 95,0 cm
 LW – Lack Weiß *White lacquer*
 Rahmengestell Weiß *Frame rack white*
- 47004 Wohnkombination *Living room combination*
 ↕ 363,2 cm ↕ 180,5 cm ↕ 51,3 cm
 BC – Kristallbuche *Beech crystal*
 LW – Lack Weiß *White lacquer*

8-9

- 47001 Sideboard mit Kufen *Sideboard with runners*
 ↕ 228,2 cm ↕ 85,3 cm ↕ 40,0 cm
 BC – Kristallbuche *Beech crystal*
 LW – Lack Weiß *White lacquer*
 Kufen Weiß *Runners white*
- 87858 Korpuselement mit Rahmengestell
Carcass element with frame rack
 ↕ 93,2 cm ↕ 139,7 ↕ 40,0 cm
 S5 – Lack Piniengrün *Pine green*
 Rahmengestell Weiß *Frame rack white*

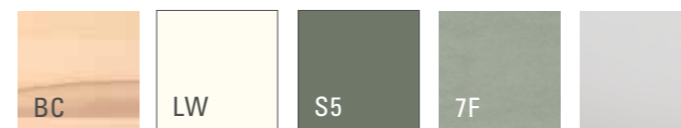







10-11

- 47011 Wohnkombi mit Kufen
Living room combination with runners
 318,2 cm 190,9 cm 49,6 cm
 BK – Kernbuche *Beech heartwood*
 P6 – Lack Taupe *Taupe lacquer*
 Kufen Anthrazit *Runners anthrazite*
- 93818 Couchtisch CUBE *Coffee table CUBE*
 120,0 cm 40,0 cm 75,0 cm
 BK – Kernbuche *Beech heartwood*

12-13

- 94326 Stuhl R4 mit Metallgestell SPYDER
Chair R4 with metal frame SPYDER
 58,0 cm 79,2 cm 62,6 cm
 4J – Velours *Velours Cloud Wood*
 Metallgestell Anthrazit *Metal frame anthrazite*
- 93826 Esstisch CUBE *Dinner table CUBE*
 180,0 cm 75,0 cm 95,0 cm
 BK – Kernbuche *Beech heartwood*
- 47013 Regalkombi mit Sockelgleitern
Carcass and shelf combination with plinth gliders
 246,1 cm 233,3 cm 40,0 cm
 BK – Kernbuche *Beech heartwood*
 P6 – Lack Taupe *Taupe lacquer*
- 47012 Korpuselement mit Sockelgleitern
Carcass element with plinth gliders
 130,7 cm 216,9 cm 41,7 cm
 BK – Kernbuche *Beech heartwood*
 P6 – Lack Taupe *Taupe lacquer*

14

- 94326 Stuhl R4 mit Metallgestell SPYDER
Chair R4 with metal frame SPYDER
 58,0 cm 79,2 cm 62,6 cm
 4J – Velours *Velours Cloud Wood*
 Metallgestell Anthrazit *Metal frame anthrazite*

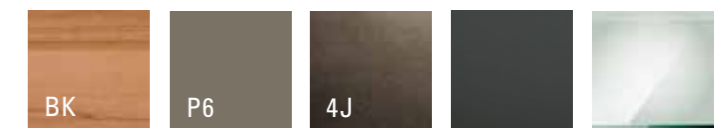









16–17

- 47014 Kompaktelement mit Kufen
+ Living room combination with runners
47010 Eckvorschlag Corner combination
↖ 374,1 × 209,1 cm ↗ 233,3 cm ↘ 49,6 cm
OA – Asteiche Knotty oak
S3 – Lack Schiefergrau Slate grey lacquer
Kufen Schwarz matt Runners black matt

- 83747 Couchtisch mit Rahmengestell Coffee table with frame rack
↖ 120,0 cm ↗ 39,6 cm ↘ 75,0 cm
OA – Asteiche Knotty oak
Rahmengestell Schwarz matt Frame rack black matt

18–19

- 2 × 87859 Korpuselement mit Rahmengestell
Carcass element with frame rack
↖ 2 × 63,2 cm ↗ 139,7 cm ↘ 42,9 cm
OA – Asteiche Knotty oak
Rahmengestell Schwarz matt Frame rack black matt

- 47009 Vitrinenschrank mit Kufen Display cabinet with runners
↖ 183,2 cm ↗ 190,9 cm ↘ 40,0 cm
OA – Asteiche Knotty oak
Kufen Schwarz matt Runners black matt

- 47008 Sideboard mit Kufen Sideboard with runners
↖ 243,2 cm ↗ 102,9 cm ↘ 40,0 cm
OA – Asteiche Knotty oak
Kufen Schwarz matt Runners black matt

- 93827 Esstisch CUBE Dinner table CUBE
↖ 200,0 cm ↗ 75,0 cm ↘ 95,0 cm
OA – Asteiche Knotty oak

- 6 × 91607 Stuhl R2 Chair R2
↖ 56,0 cm ↗ 82,5 cm ↘ 59,0 cm
OA – Asteiche Knotty oak
6L – Stoff Fabric Willow Sapphire

- 2 × 91611 Stuhl R2 mit Armlehne Chair R2 with arm rest
↖ 54,8 cm ↗ 90,5 cm ↘ 57,5 cm
OA – Asteiche Knotty oak
6L – Stoff Fabric Willow Sapphire

20–21

- 47008 Sideboard mit Kufen Sideboard with runners
↖ 243,2 cm ↗ 102,9 cm ↘ 40,0 cm
OA – Asteiche Knotty oak
Kufen Schwarz matt Runners black matt

22–23

- 47009 Vitrinenschrank mit Kufen Display cabinet with runners
↖ 183,2 cm ↗ 190,9 cm ↘ 40,0 cm
OA – Asteiche Knotty oak
Kufen Schwarz matt Runners black matt

- 2 × 87859 Korpuselement mit Rahmengestell
Carcass element with frame rack
↖ 2 × 63,2 cm ↗ 139,7 cm ↘ 42,9 cm
OA – Asteiche Knotty oak
Rahmengestell Schwarz matt Frame rack black matt









24–25

- 47006 Wohnkombination mit Kufen
Living room combination with runners
 ↳ 243,2 cm ↳ 85,3 cm ↳ 49,6 cm
 NN – Nussbaum Nova *Knotty oak*
 LG – Lack Graphit *Graphite lacquer*
 Kufen Schwarz matt *Runners black matt*
- 47007 Sideboard mit Kufen *Sideboard with runners*
 ↳ 258,2 cm ↳ 102,9 cm ↳ 41,7 cm
 NN – Nussbaum Nova *Knotty oak*
 LG – Lack Graphit *Graphite lacquer*
 Kufen Schwarz matt *Runners black matt*
- 92378 Couchtisch *Coffee table*
 ↳ 72,0 cm ↳ 40,0 cm ↳ 72,0 cm
 + ↳ 100,0 cm ↳ 41,3 cm ↳ 75,0 cm
 NN – Nussbaum Nova *Knotty oak*
 LG – Lack Graphit *Graphite lacquer*

26–27

- 47000 Sideboard mit Kufen *Sideboard with runners*
 ↳ 243,2 cm ↳ 85,3 cm ↳ 49,6 cm
 NN – Nussbaum Nova *Knotty oak*
 LG – Lack Graphit *Graphite lacquer*
 Kufen Schwarz matt *Runners black matt*
- 6× 93801 Stuhl R5 mit Armlehne *Chair R5 with arm rest*
 ↳ 56,0 cm ↳ 85,0 cm ↳ 56,5 cm
 NN – Nussbaum Nova *Knotty oak*
 5G – Stoff *Fabric Ocean Curry*
- 90975 Esstisch *Dinner table*
 ↳ 190,0 cm ↳ 78,0 cm ↳ 95,0 cm
 NN – Nussbaum Nova *Knotty oak*
 LG – Lack Graphit *Graphite lacquer*
 R5 – Lack Brillantgrau *Diamond grey lacquer*
- 2× 87857 Korpuselement mit Kufen *Carcass element with runners*
 ↳ 2× 78,2 cm ↳ 190,9 ↳ 40,0 cm
 NN – Nussbaum Nova *Knotty oak*
 LG – Lack Graphit *Graphite lacquer*
 Kufen Schwarz matt *Runners black matt*

28–29

- 2× 87857 Vitrine mit Kufen *Display cabinet with runners*
 ↳ 2× 78,2 cm ↳ 190,9 ↳ 40,0 cm
 NN – Nussbaum Nova *Knotty oak*
 LG – Lack Graphit *Graphite lacquer*
 Kufen Schwarz matt *Runners black matt*



NN

LG

R5

5G



Front + Korpus Front + Carcass

- | | | | |
|--|---|---|---------------------------------------|
| LW Lack Weiß <i>white lacquer</i> | LC Lack Crema <i>crema lacquer</i> | R6 Lack Seidengrau <i>silk grey l.</i> | S1 Lack Macchiata <i>macchiata l.</i> |
| R4 Lack Cashmere <i>cashmere l.</i> | R3 Lack Olivgrau <i>olive grey l.</i> | R5 L. Brillantgrau <i>diamond grey l.</i> | LY Lack Grau <i>grey lacquer</i> |
| LH Lack Platingrau <i>platinum grey l.</i> | P6 Lack Taupe <i>taupe lacquer</i> | LT Lack Terra <i>terra lacquer</i> | R2 Lack Espresso <i>espresso l.</i> |
| LZ Lack Ziegelrot <i>brick lacquer</i> | DR Lack Dark Red <i>dark red l.</i> | R8 Lack Oxidrot <i>oxide red l.</i> | R7 Lack Rosewood <i>rosewood l.</i> |
| S2 Lack Marill <i>marill lacquer</i> | S5 L. Piniengrün <i>pine green l.</i> | P9 Lack Agave <i>agave lacquer</i> | P8 Lack Ocean <i>ocean lacquer</i> |
| S4 L. Atlantikblau <i>atlantic blue l.</i> | S3 L. Schiefergrau <i>slate grey l.</i> | LG Lack Graphit <i>graphite lacquer</i> | LS Lack Schwarz <i>black lacquer</i> |

Alle Lacke auch in Hochglanz erhältlich
All finishes are also available in high-gloss type

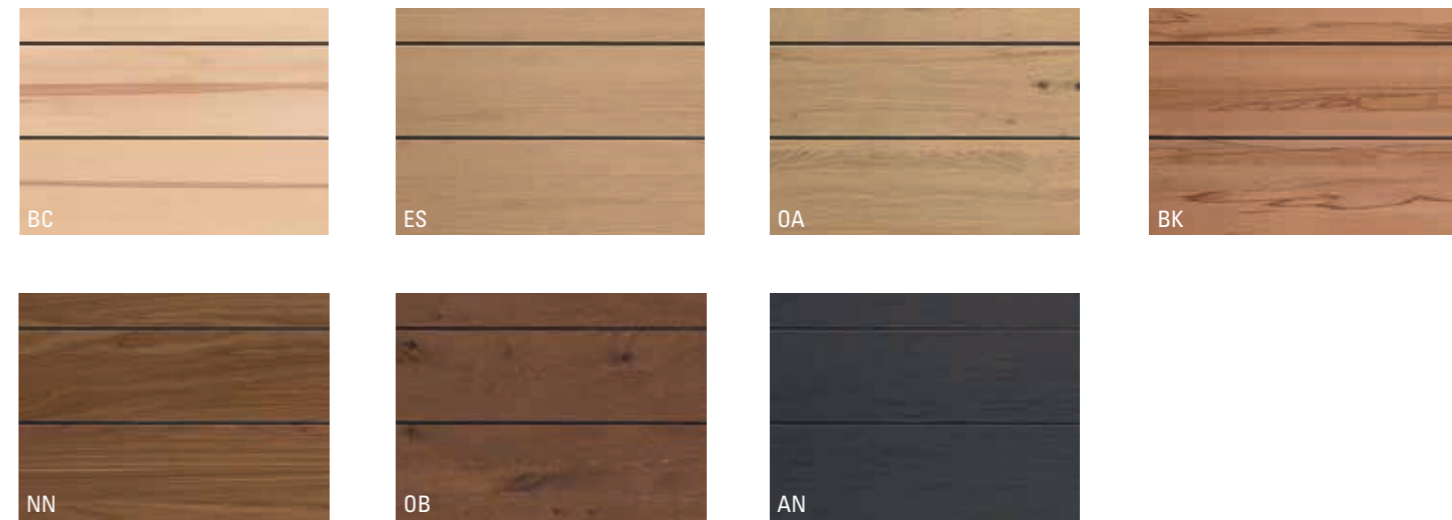
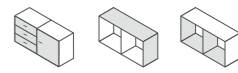

Front + Korpus furniert Front + Carcass veneered

- | | | | |
|---------------------------------------|---|--------------------------------------|-------------------------------------|
| BC Kristallbuche <i>Beech crystal</i> | ES Eiche Sand <i>Sand oak</i> | OA Asteiche <i>Knotty oak</i> | BK Kernbuche <i>Beech heartwood</i> |
| NN Nussbaum Nova <i>Walnut nova</i> | OB Asteiche Bourbon <i>Knotty oak bourbon</i> | AN Eiche Graphit <i>Graphite oak</i> | |

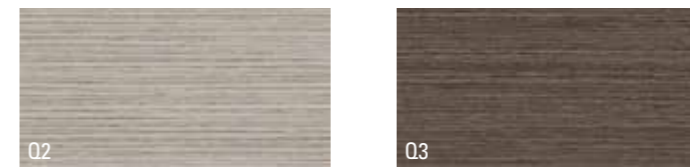

Akzentausführung: Feinschliff Accent finishes: Fine sanded

- | | |
|---|---|
| Q2 Feinschliff Bianco <i>Fine sanded Bianco</i> | Q2 Feinschliff Grigio <i>Fine sanded Grigio</i> |
|---|---|

Innenausführung: Dekor Interior finish: Décor

Griffe Handles

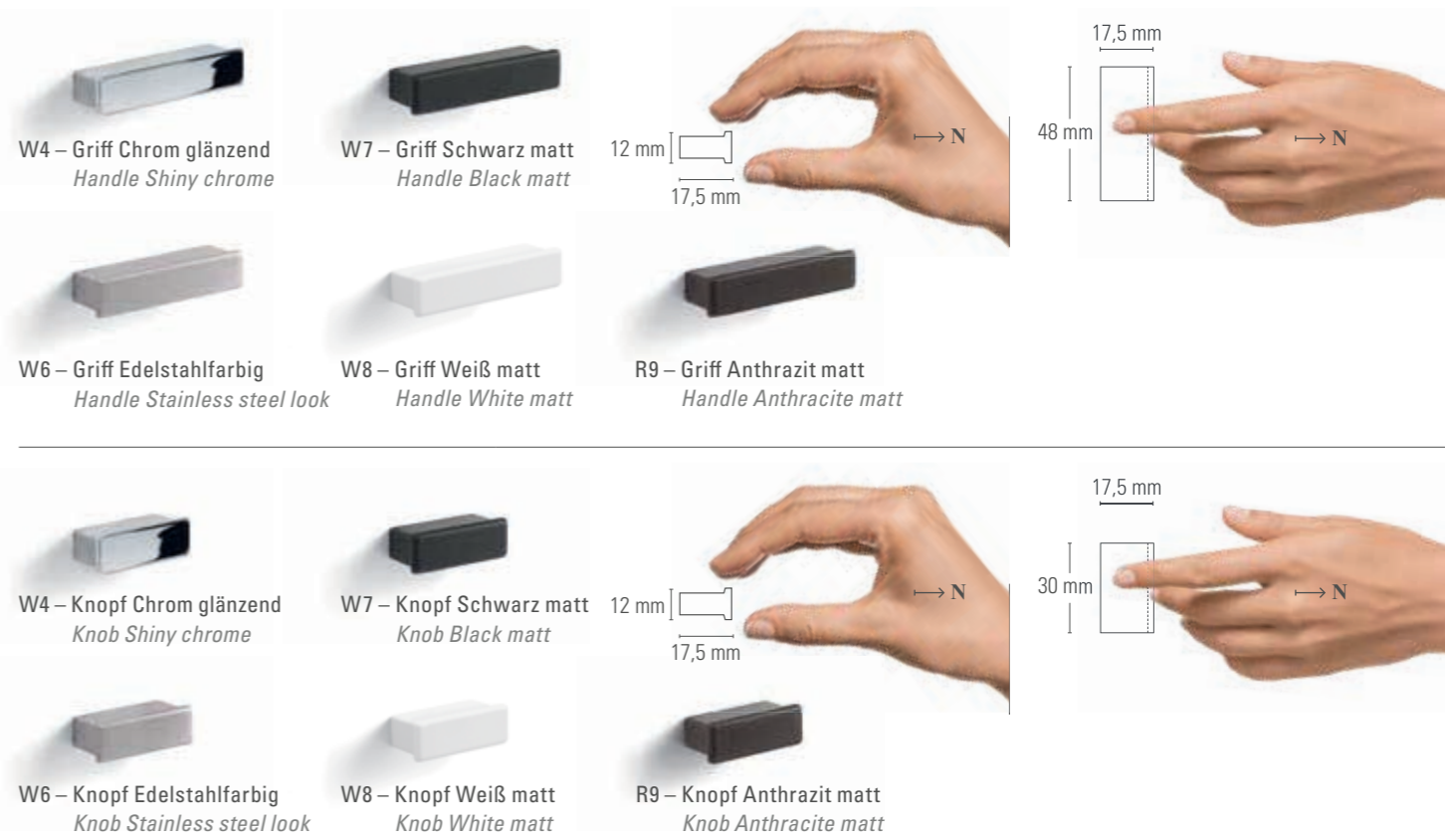

W4 – Griff Chrom glänzend
Handle Shiny chrome

W7 – Griff Schwarz matt
Handle Black matt

12 mm | 17,5 mm

17,5 mm | 48 mm

W6 – Griff Edelstahlfarbig
Handle Stainless steel look

W8 – Griff Weiß matt
Handle White matt

R9 – Griff Anthrazit matt
Handle Anthracite matt

W4 – Knopf Chrom glänzend
Knob Shiny chrome

W7 – Knopf Schwarz matt
Knob Black matt

12 mm | 17,5 mm

17,5 mm | 30 mm

W6 – Knopf Edelstahlfarbig
Knob Stainless steel look

W8 – Knopf Weiß matt
Knob White matt

R9 – Knopf Anthrazit matt
Knob Anthracite matt

Leder HERMES Leather HERMES



Vegane Lederalternative PURE Vegan leather alternative PURE



Velours CLOUD Velours CLOUD

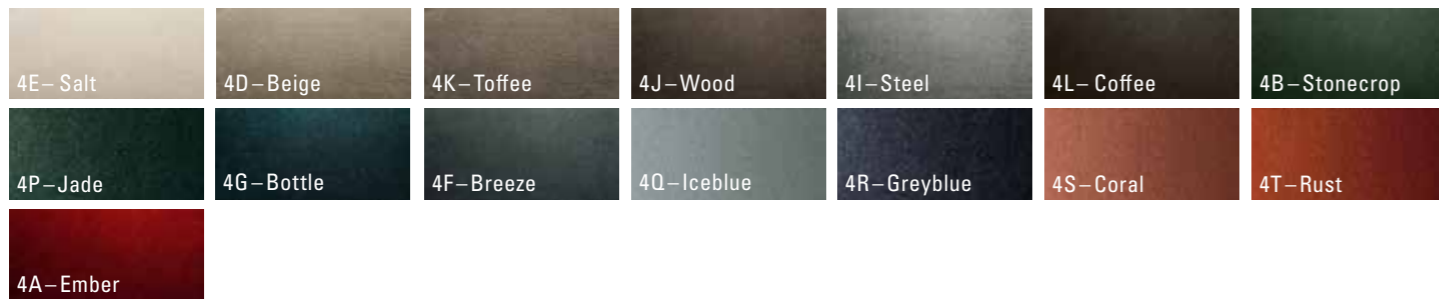

Flachgewebe OCEAN Flat woven fabric OCEAN

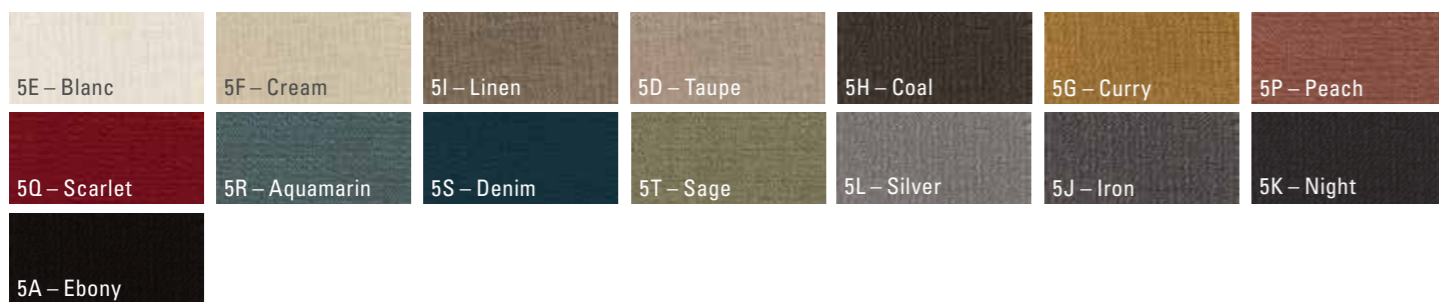

Flachgewebe WILLOW Flat woven fabric WILLOW



Beispielartikel Sample article

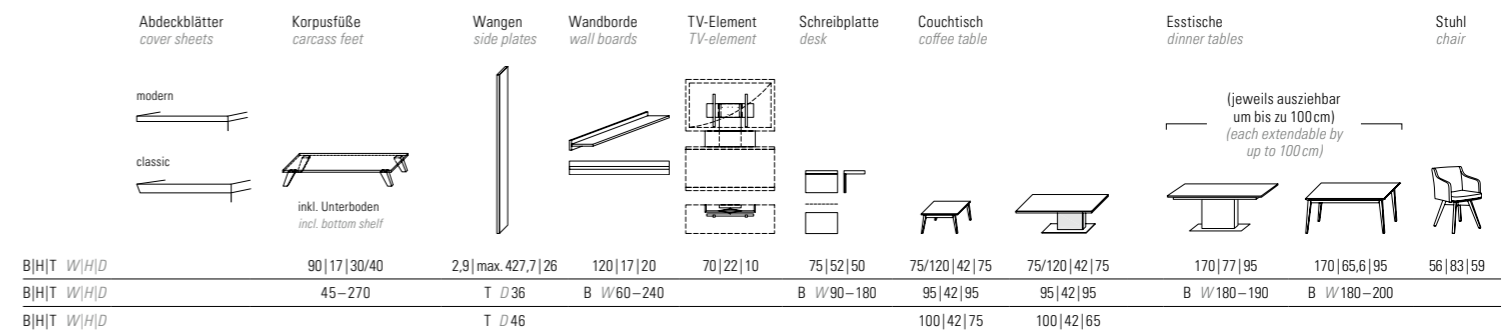
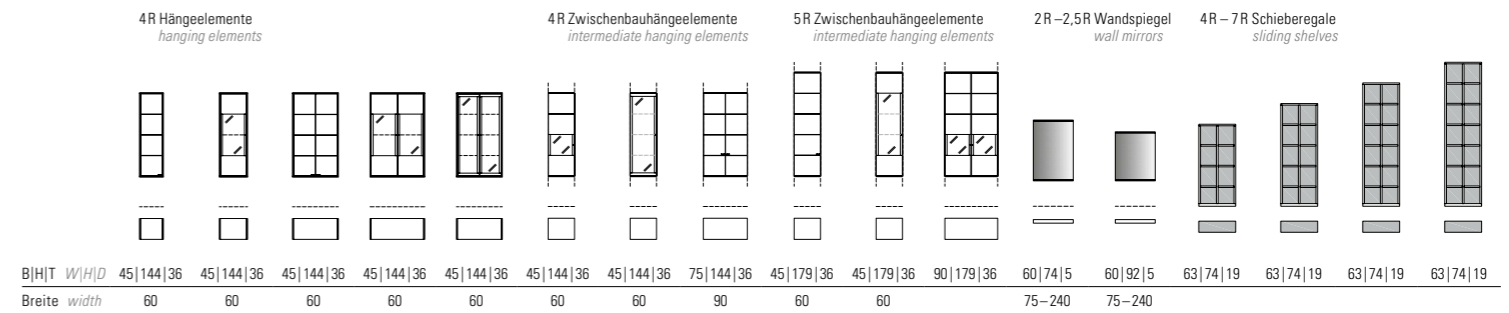
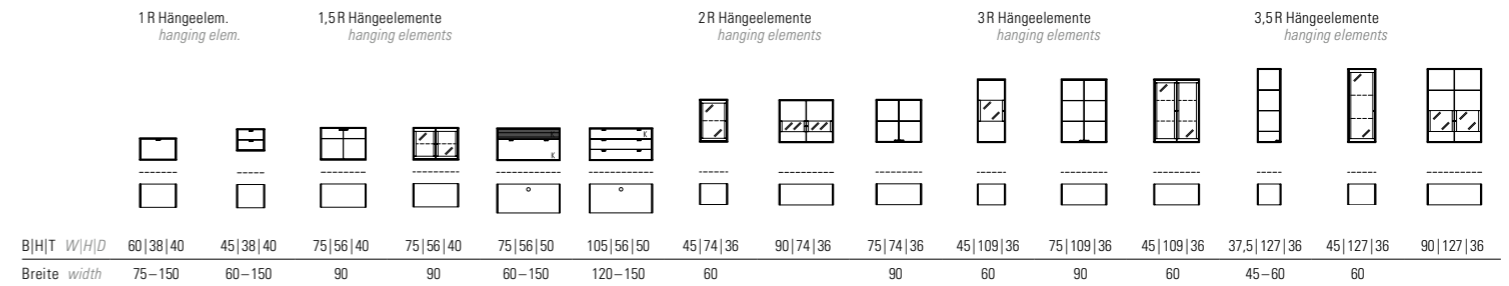
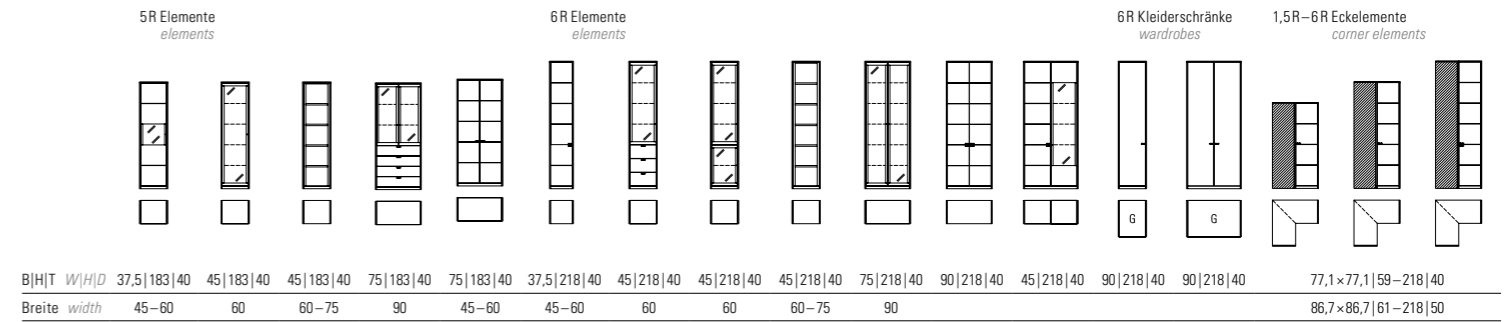
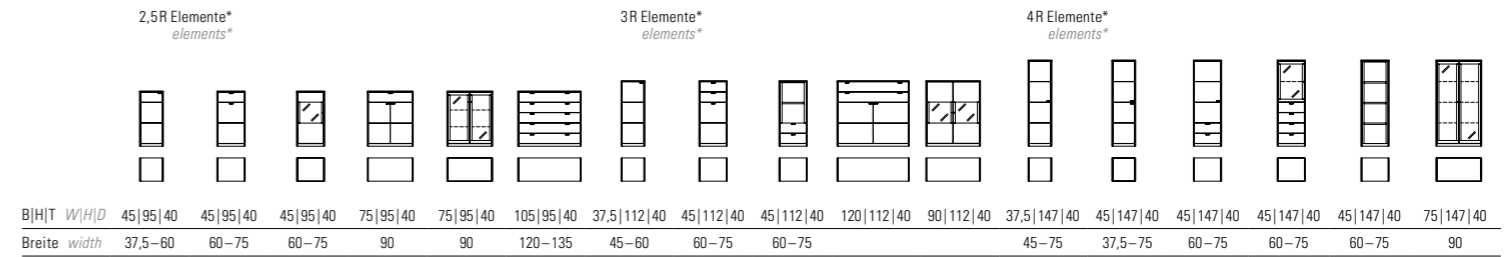
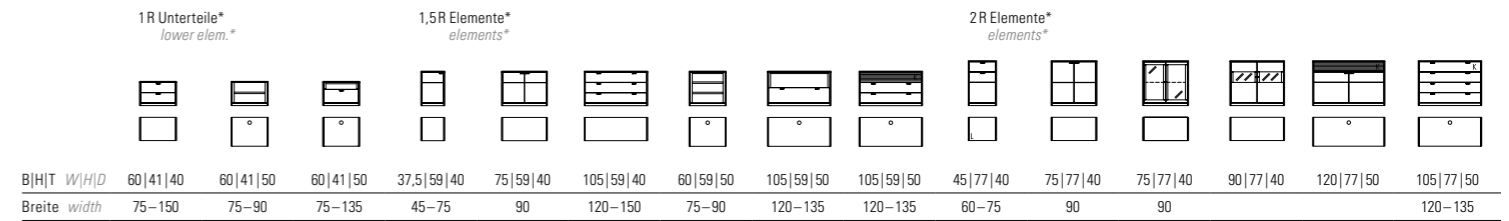

* Auch in Komforttiefe 49,2 cm erhältlich • Alle Angaben in cm • Für einen vollständigen Überblick über alle lieferbaren Typen wenden Sie sich bitte an den Fachhandel • Abweichung im Design, in technischer Ausführung und Druckfehler vorbehalten; Grundlage aller Lieferungen ist unsere Preis-/Typenliste.
 * Also available in comfort depth of 49,2 cm • All specifications in cm • For a complete overview of all available types please contact an authorised dealer • Subject to changes in design, technical execution and printing errors.
 All deliveries based on our price/type list.

Ein wichtiges Design- und Unterscheidungsmerkmal sind die leicht aus dem Korpus hervorstehenden Nischenelemente. Durch die individuelle Wahl der Ausführung von Korpus und Korpushülle lassen sich emotionale Farbakkente setzen, kontrastreich, farbharmenisch oder uni. Ein weiteres Merkmal sind die neuen kubisch-modernen Metallkufen, die in schwarz, weiß, Chrom glänzend und Edelstahl zur Auswahl stehen. Passend zu den Kufen kommen formschöne Griffe zum Einsatz, im Standard wird dieses Modell als Push to open Möbel gefertigt.

An important design and distinguishing feature are the recess elements that protrude slightly from the carcass. With an individual choice of design for the carcass and carcass shell, set emotional colour accents with pronounced contrasts, harmonious colours or a single colour. Another feature are the new cubic-modern metal runners, available in black, white, anthracite, glossy chrome and stainless steel. There are beautifully shaped handles to match the runners; this model is manufactured as standard as a push-to-open item of furniture.



Beleuchtung: Sie können Ihr Möbel mit umfangreichen Beleuchtungsoptionen ausstatten: LEDs mit einer angenehmen Lichttemperatur in den Wandborden und Glaskanten sowie als Spots in den Vitrinen. Besonders komfortabel können Sie die verschiedenen Beleuchtungen mit der neuen 5-Kanal-Funkfernbedienung steuern.

Lighting: You can choose from extensive lighting options for your furniture – LEDs with a pleasant light temperature in the wall boards and glass edges as well as spots in the cabinets. The new 5-channel radio remote control allows for a particularly comfortably control of the various lighting systems.



Das LED-Lichtband erzeugt eine gleichmäßige warmweiße Lichtstimmung.* The LED lighting strip produces a uniform, warm white light mood.*



*Die Leuchten enthalten LED-Lampen, die innerhalb der Energieklasse E bis F liegen. Die LED-Lampen können nicht ausgetauscht werden.
*The lamp is equipped with energy class E to F LEDs. The LEDs cannot be replaced.

Mit der Funkfernbedienung steuern Sie ganz bequem die einzelnen Beleuchtungskomponenten in Ihren Möbeln.
It is easy to operate the individual lighting components of your furniture with the remote control.

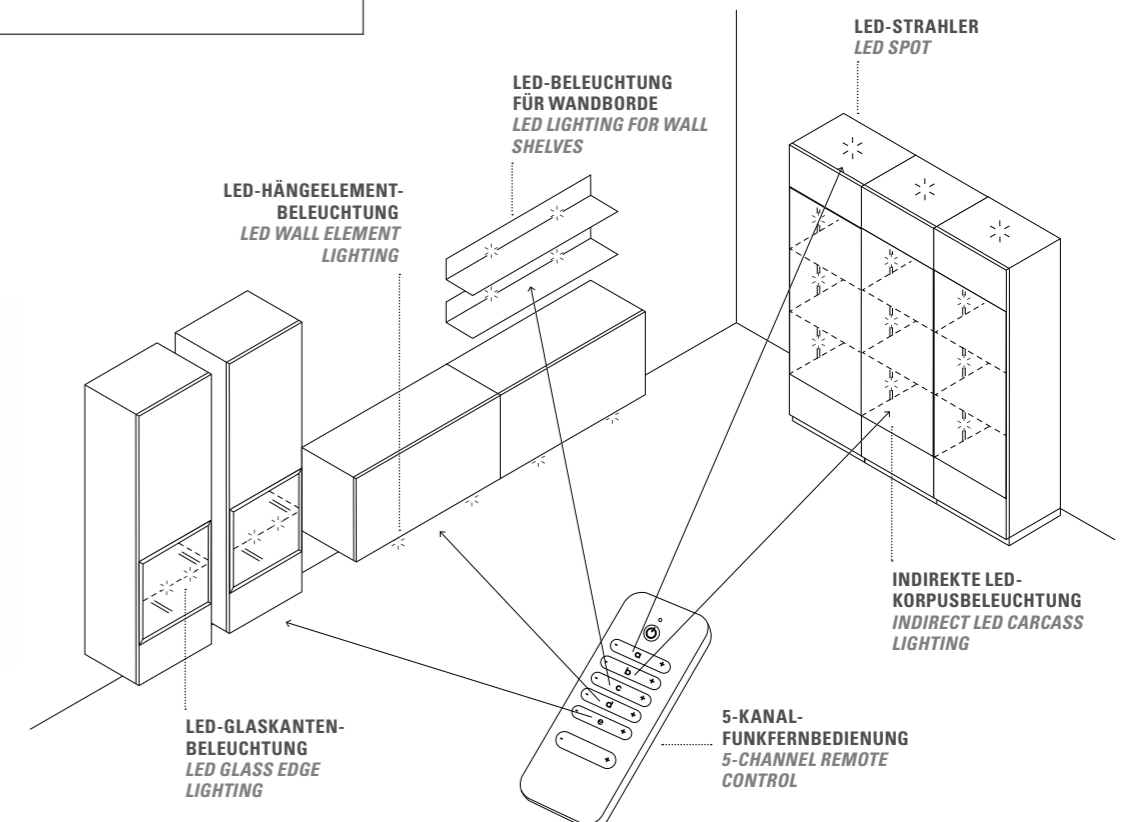

Programm 2023 *Programme 2023*

